

建 杵

1219

鳥居型杵(ピン付)

品番	質量(kg)
SA4055B	16.1

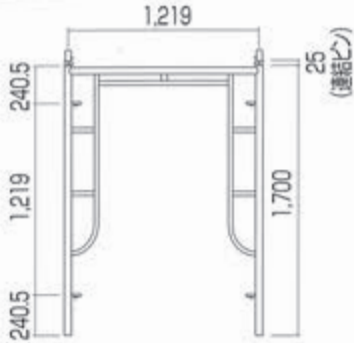

梯子型杵

品番	質量(kg)
SA405L	16.4
(鳥居型 SA405)	16.7



梯子型杵

品番	質量(kg)
SA404L	14.4

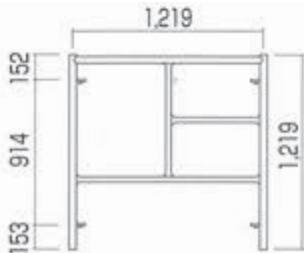

梯子型杵

品番	質量(kg)
SA403L	11.4

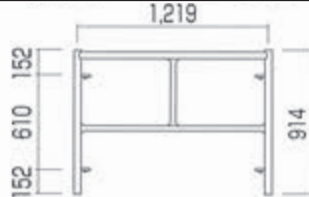

調節杵

品番	質量(kg)
SA417	9.1

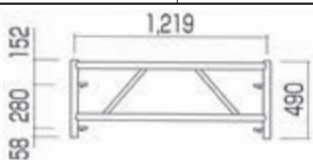

914

鳥居型杵(ピン付)

品番	質量(kg)
A3055A	14.1

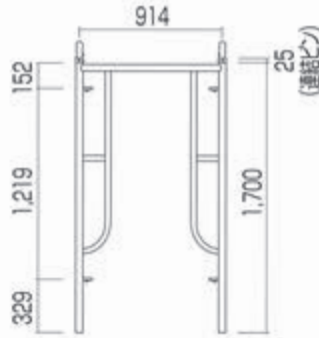

鳥居型杵

品番	質量(kg)
SN305	13.8

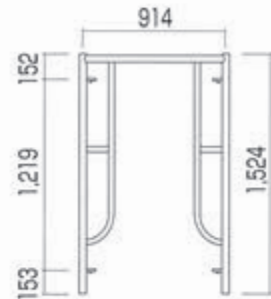

梯子型杵

品番	質量(kg)
SA304L	14.4

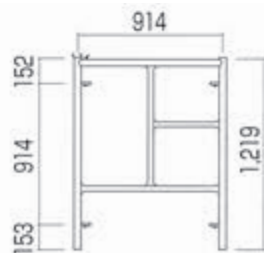

梯子型杵

品番	質量(kg)
A303L	8.5

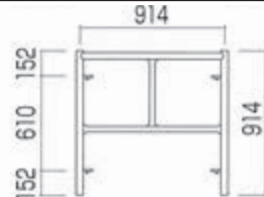

調節杵

品番	質量(kg)
A317	6.8

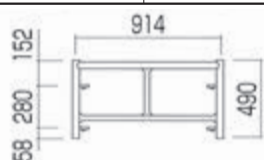

610

簡易型杵(ピン付)

品番	質量(kg)
A6155A	12.3

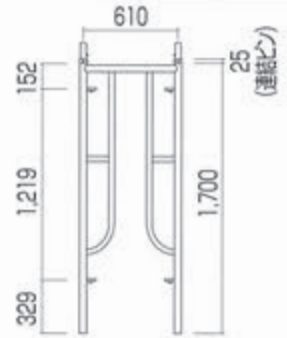

簡易型杵

品番	質量(kg)
SN205	10.7

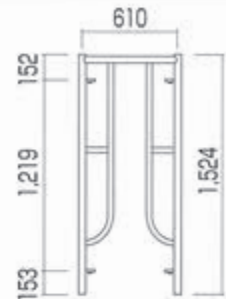

調節杵

品番	質量(kg)
SN204	12.0

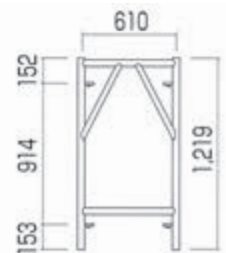

調節杵

品番	質量(kg)
SN203	10.2

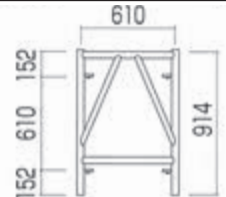

調節杵

品番	質量(kg)
SN217	6.3

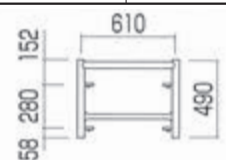

1700

1524

1219

914

490